

SC SERIES

PAGING HORN SPEAKERS

TOA SC SERIES PAGING HORN SPEAKERS provide intelligible voice paging and tone signaling for indoor and outdoor sound system applications.

Fully weather-resistant for reliable operation in demanding environmental conditions, SC Series models are available with a choice of power ratings from 10 W to 50 W and a built-in 25 V / 70.7 V transformer with external screwdriver-adjustable power taps. The SC Series are easy to install in wall, pole or ceiling-mount applications and include corrosion-resistant stainless-steel mounting hardware. The SC Series models are also designed for intercom talk-back applications requiring dual operation as both a microphone and speaker.

Each model is a double re-entrant horn with compression driver for high sensitivity and a lightweight aluminum enclosure. The loudspeaker diaphragm is heat and moisture-resistant to prevent deformation and extend operation. The SC Series are also IP-65 standards compliant for dust and moisture-resistance with a wide operating temperature range from -4° F to 130° F.

The SC Series Paging Horn Speakers are backed with a five year warranty.

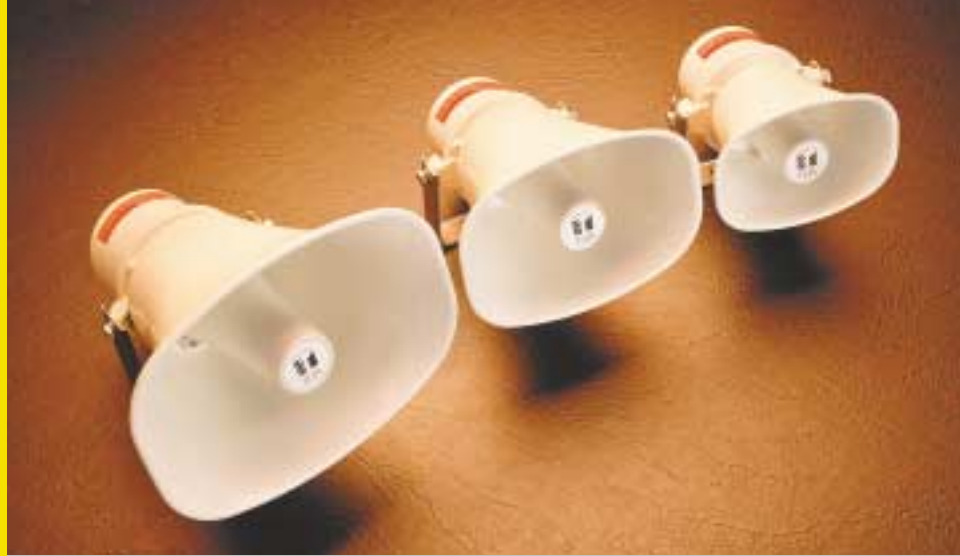

HIGHLIGHTS

- **Paging Horn Speakers** for voice paging and tone signaling distribution.
- **Weather-Resistant** to withstand demanding environmental conditions.
- **Double Re-Entrant Horn with Compression Driver**
- **Controlled Dispersion**
- **High Sensitivity** up to 113 dB (1 W/1 m).
- **Usable as a Microphone** for intercom talk-back applications.
- **Built-In 25 V / 70.7 V Transformer ("T" Models)** with screwdriver-adjustable power taps (8 and 16 ohm models also available).
- **Lightweight, Sealed, Aluminum Enclosure** prevents moisture damage.
- **Cable Strain-Relief**
- **IEC IP-65 Standards Compliant** for dust and moisture-resistance.
- **Wide Temperature Range** -4° F to 131° F
- **Phenolic Loudspeaker Diaphragm** prevents deformation from heat and moisture.
- **Stainless-Steel Mounting Bracket** for easy installation and aiming in wall, pole or ceiling-mount applications.
- **Five Year Warranty**

SC SERIES MODELS

- **SC-610:** 10 W, 8 ohms
- **SC-610T:** 10 W, w/ Transformer
- **SC-615:** 15 W, 8 ohms
- **SC-615T:** 15 W, w/ Transformer
- **SC-630:** 30 W, 8 ohms
- **SC-630T:** 30 W, w/ Transformer
- **SC-650:** 50 W, 16 ohms

APPLICATIONS

- **Boats**
- **Churches**
- **Drive-Thru**
- **Industrial**
- **Mobile Vehicles**
- **Parking Facilities**
- **Parks**
- **Schools**
- **Security**
- **Sporting Facilities**
- **Swimming Pools**

SPECIFICATIONS

SC SERIES PAGING HORN SPEAKERS

Tel: 800-733-7088
Fax: 800-733-9766
www.toaelectronics.com



Enclosure Type	Double Re-Entrant Horn
Speaker Component	Compression Driver
Power Handling	SC-610/T: 10 W SC-615/T: 15 W SC-630/T: 30 W SC-650: 50 W
Transformer Taps / Rated Impedance	SC-610, SC-615, SC-630: 8 ohms SC-650: 16 ohms SC-610T: 70.7V: 10 W (500 Ω) 5 W (1 kΩ) 2.5 W (2 kΩ) 25 V: 10 W (63 Ω) 5 W (130 Ω) 1.3 W (500 Ω) 0.6 W (1 kΩ) 0.3 W (2 kΩ) SC-615T: 70.7V: 15 W (330 Ω) 7.5 W (650 Ω) 3.8 W (1.3 kΩ) 25 V: 15 W (42 Ω) 7.5 W (83 Ω) 1.9 W (330 Ω) 1 W (650 Ω) 0.5 W (1.3 kΩ) SC-630T: 70.7V: 30 W (170 Ω) 15 W (330 Ω) 7.5 W (650 Ω) 25 V: 30 W (21 Ω) 15 W (42 Ω) 3.7 W (170 Ω) 1.9 W (330 Ω) 1 W (650 Ω)
Sensitivity (Sound Pressure Level) (1 W / 1 m, 500 Hz to 2,500 Hz)	SC-610/T: 110 dB SPL SC-615/T: 112 dB SPL SC-630/T: 113 dB SPL SC-650: 108 dB SPL
Frequency Response	SC-610/T: 315 Hz - 12.5 kHz SC-615/T: 280 Hz - 12.5 kHz SC-630/T: 250 Hz - 10 kHz SC-650: 250 Hz - 6 kHz

Dispersion (-6 dB, 2 kHz)	SC-610/T: 70° H x 100° V SC-615/T: 70° H x 90° V SC-630/T: 55° H x 70° V SC-650: 55° H x 45° V
Sensitivity as Microphone (0 dB = 1 mW / 10 dynes / cm ²)	SC-610/T: -24 dB at 1 kHz SC-615/T: -22 dB at 1 kHz SC-630/T: -20 dB at 1 kHz SC-650: n/a
IEC IP Code	IP-65
Temperature Range	-4° F to 131° F (-20° C to +55° C)
Material/Finish	Horn Flare: Aluminum, Off-White, Powder Coating Reflector Horn and Rear Cover: ABS Resin, Off-White Bracket, Screws and Bolts: Stainless Steel Speaker Cable: Polyvinyl Chloride Insulated (Diameter: 0.24" (6 mm), Length: 24" (600 mm))
Dimensions (W x H x D)	SC-610/T: 6.77" x 6.34" x 7.40" (172 mm x 161 mm x 188 mm) SC-615/T: 8.74" x 7.04" x 9.21" (222 mm x 179 mm x 234 mm) SC-630/T: 11.22" x 8.94" x 10.91" (285 mm x 227 mm x 277 mm) SC-650: 15.39" x 11.93" x 12.87" (391 mm x 303 mm x 327 mm)
Weight	SC-610: 1.76 lbs. (0.8 kg.) SC-610/T: 2.43 lbs. (1.1 kg.) SC-615: 2.21 lbs. (1.0 kg.) SC-615/T: 2.43 lbs. (1.1 kg.) SC-630: 3.09 lbs. (1.4 kg.) SC-630/T: 4.19 lbs. (1.9 kg.) SC-650: 7.06 lbs. (3.2 kg.)
Options	YS-151S: Swivel-Mount Bracket (can be used instead of supplied U-bracket)

SPECIFICATIONS

SC SERIES PAGING HORN SPEAKERS

Tel: 800-733-7088
 Fax: 800-733-9766
 www.toaelectronics.com



DIMENSIONAL DRAWINGS

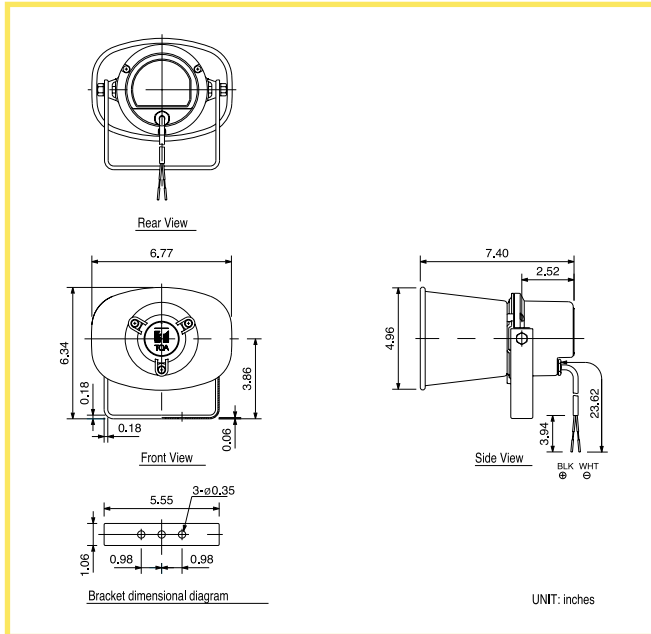

SC-610/SC-610T

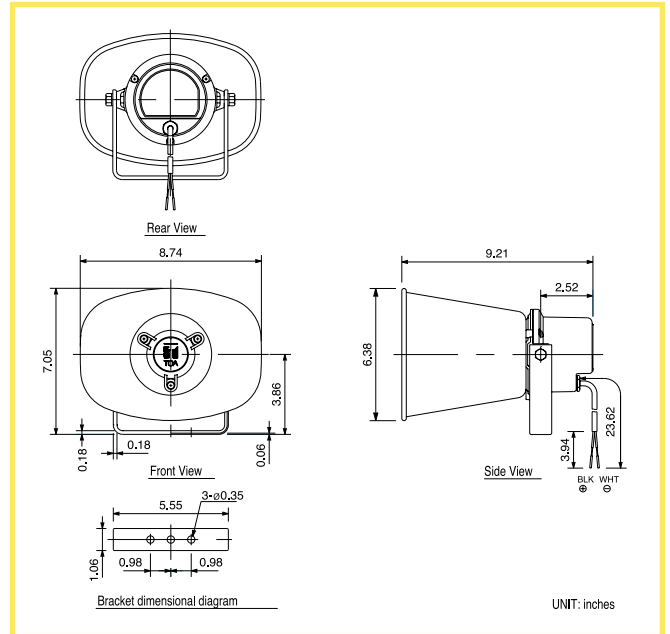

SC-615/SC-615T

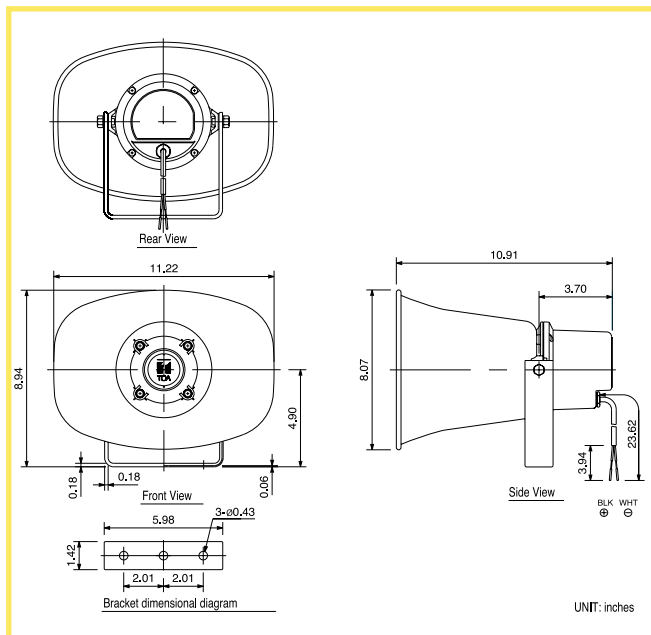

SC-630/SC-630T

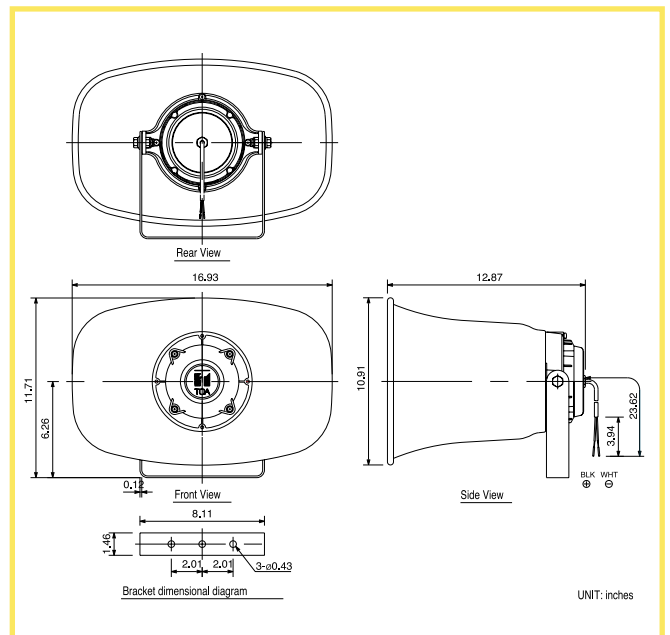

SC-650

SPECIFICATIONS

SC SERIES PAGING HORN SPEAKERS

Tel: 800-733-7088
 Fax: 800-733-9766
 www.toaelectronics.com



SC-610/SC-610T

Frequency Response

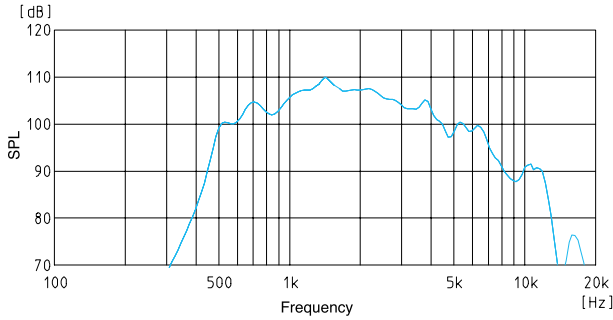

Beamwidth

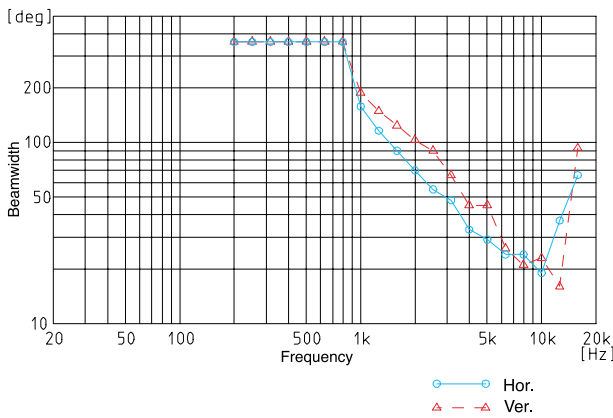

Directivity Factor

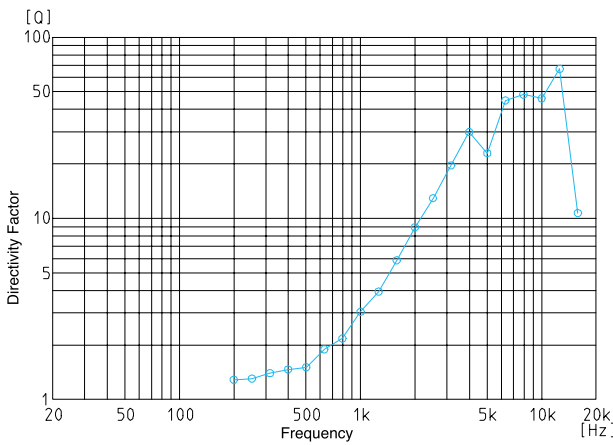

Polar Response

Horizontal

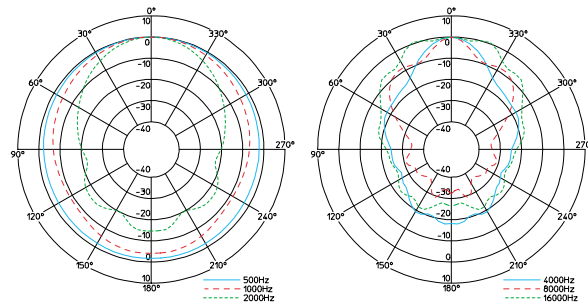

Vertical

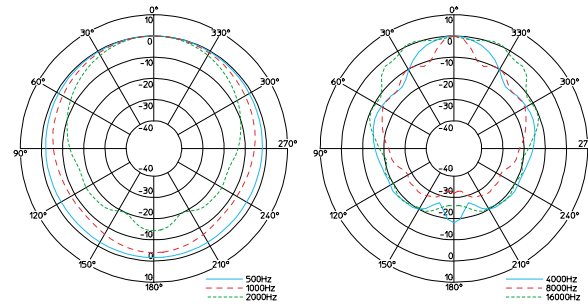

Microphone Response

Frequency Response

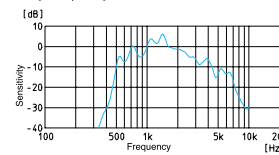

Beamwidth

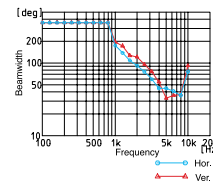

Polar Response

Horizontal

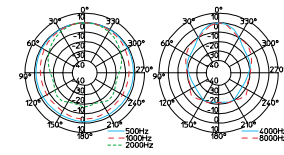

Vertical

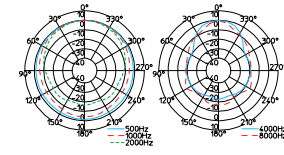



SC-615/SC-615T

Frequency Response

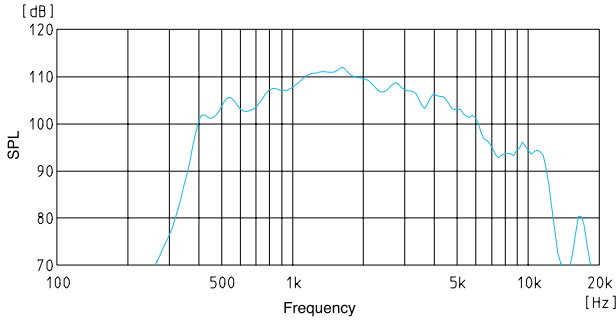

Beamwidth

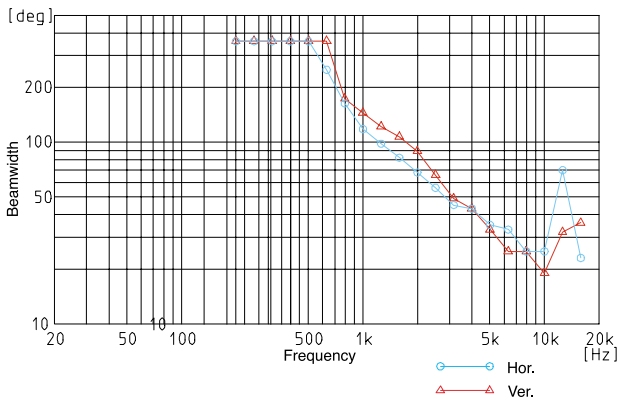

Directivity Factor

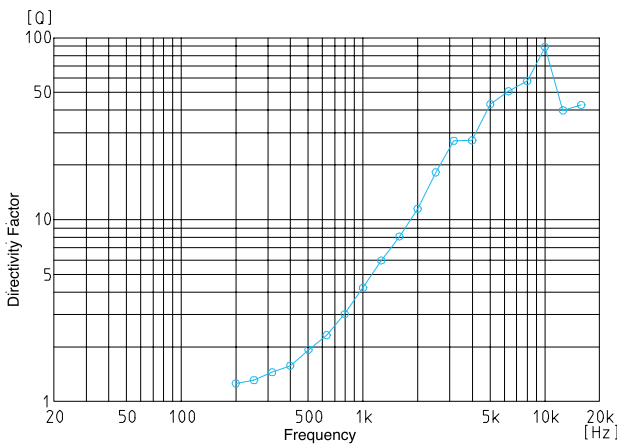

Polar Response

Horizontal

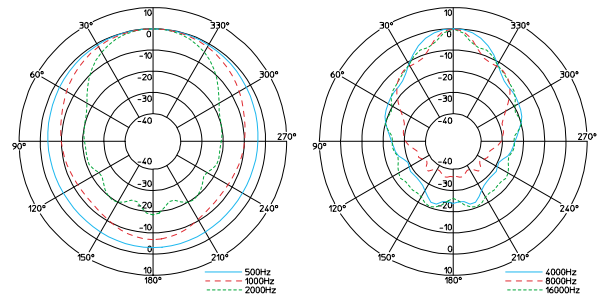

Vertical

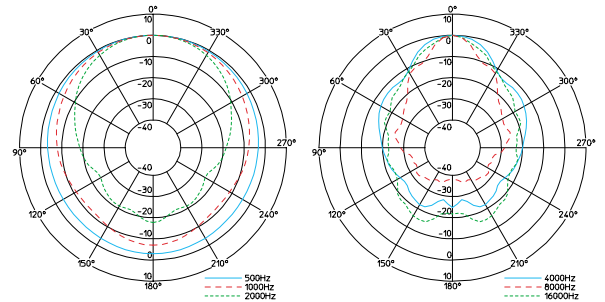

Microphone Response

Frequency Response

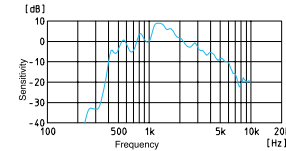

Polar Response

Horizontal

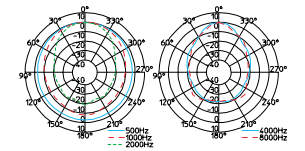

Vertical

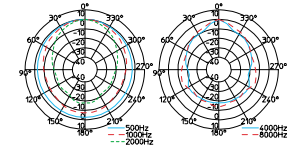

Beamwidth

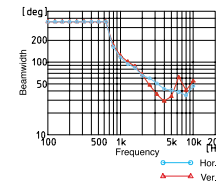

SPECIFICATIONS

SC SERIES PAGING HORN SPEAKERS

Tel: 800-733-7088
 Fax: 800-733-9766
 www.toaelectronics.com



SC-630/SC-630T

Frequency Response

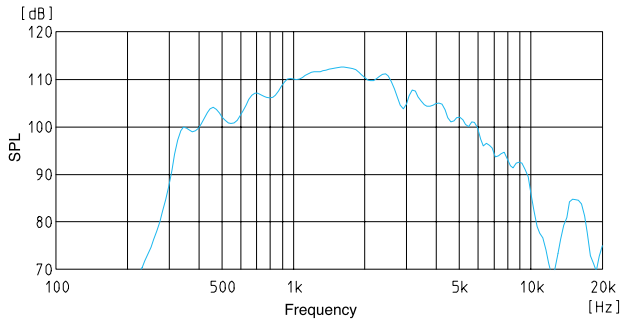

Polar Response

Horizontal

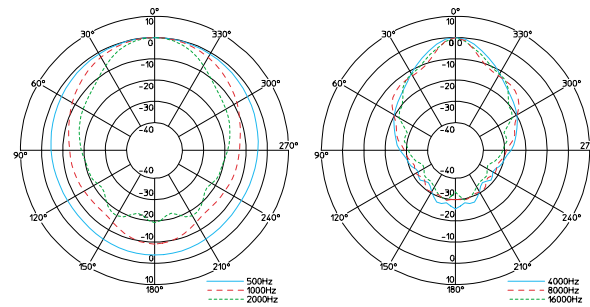

Beamwidth

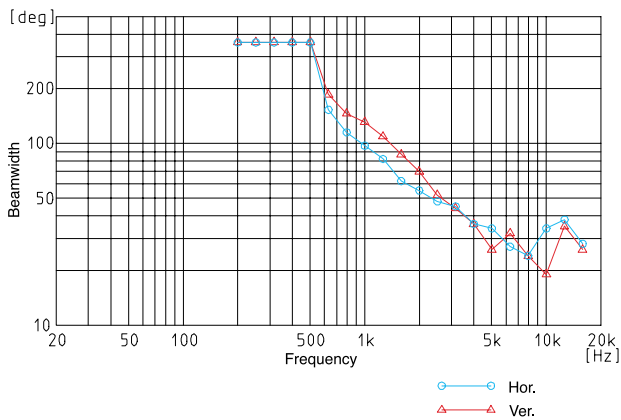

Vertical

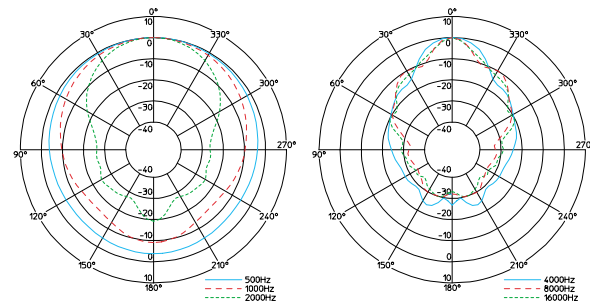

Directivity Factor

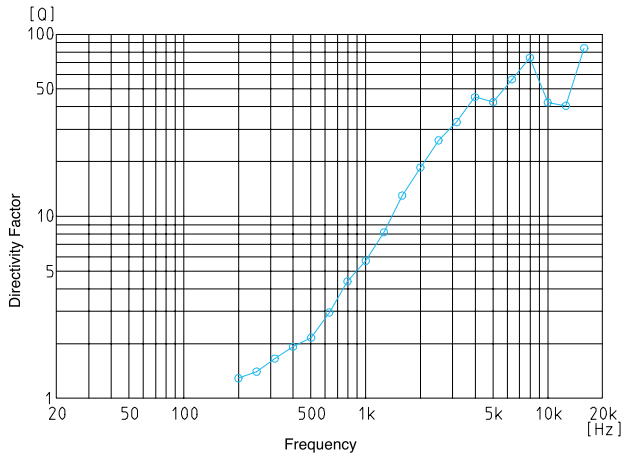

Microphone Response

Frequency Response

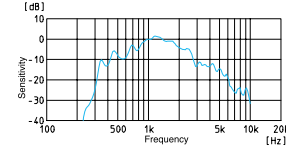

Polar Response

Horizontal

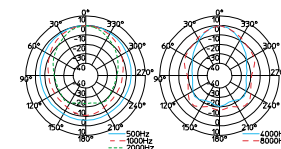

Vertical

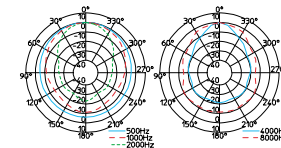

Beamwidth

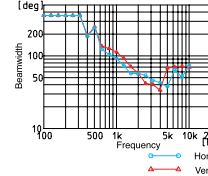



SC - 650

Frequency Response

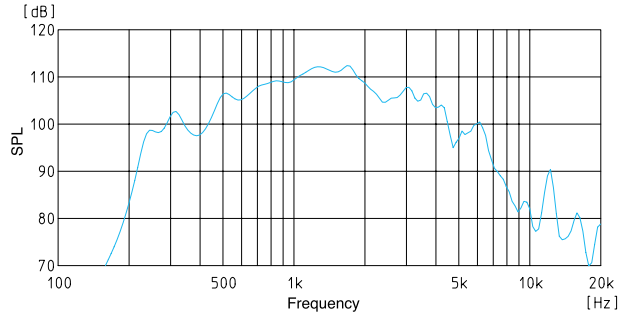

Polar Response

Horizontal

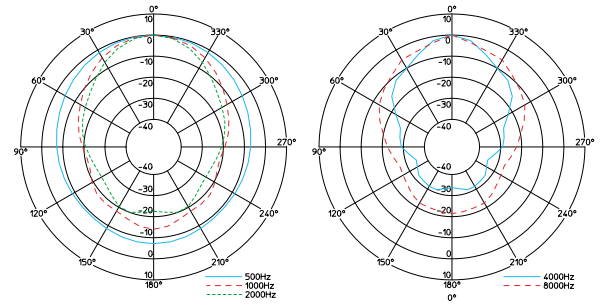

Vertical

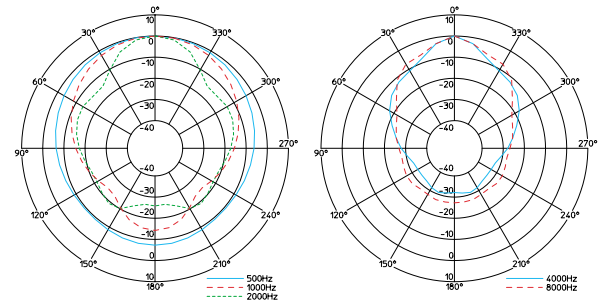

Beamwidth

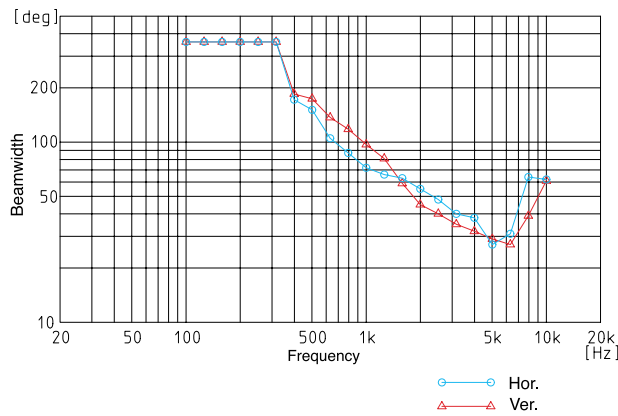

Directivity Factor

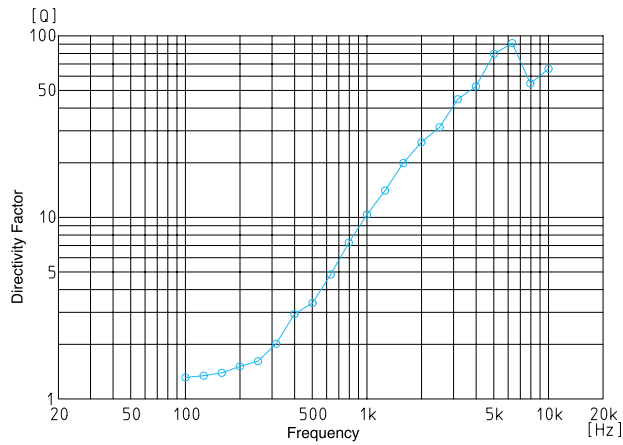

SPECIFICATIONS

SC SERIES PAGING HORN SPEAKERS

Tel: 800-733-7088
Fax: 800-733-9766
www.toaelectronics.com



ARCHITECT'S & ENGINEER'S SPECIFICATIONS

The paging horn speaker shall be a double re-entrant design suitable for paging and tone signaling distribution. The speaker component shall be a compression driver with a phenolic diaphragm to prevent deformation from heat and moisture. Power handling shall be SC-610/T: 10 W; SC-615/T: 15 W; SC-630/T: 30 W; SC-650: 50 W. Impedance of non-transformer versions shall be SC-610/615/630: 8 ohms; SC-650: 16 ohms. The paging speaker shall include a matching transformer for connection to 25 V and 70.7 V speaker lines. Transformer wattage taps shall include SC-610T: 70.7 V: 10 W (500 ohms), 5 W (1 kohms), 2.5 W (2 kohms); 25 V: 10 W (63 ohms), 5 W (130 ohms), 1.3 W (500 ohms), 0.6 W (1 kohms), 0.3 W (2 kohms); SC-615T: 70.7 V: 15 W (330 ohms), 7.5 W (650 ohms), 3.8 W (1.3 kohms); 25 V line: 15 W (42 ohms), 7.5 W (83 ohms), 1.9 W (330 ohms), 1 W (650 ohms), 0.5 W (1.3 kohms); SC-630T: 70.7 V: 30 W (170 ohms), 15 W (330 ohms), 7.5 W (650 ohms); 25 V: 30 W (21 ohms), 15 W (42 ohms), 3.7 W (170 ohms), 1.9 W (330 ohms), 1 W (650 ohms). Sound pressure level measured at one meter with one watt of power applied from 500 Hz to 2,500 Hz shall be SC-610/T: 110 dB SPL; SC-615/T: 112 dB SPL; SC-630/T: 113 dB SPL; SC-650: 108 dB SPL. Frequency response shall be SC-610/T: 315 Hz - 12.5 kHz; SC-615/T: 280 Hz - 12.5 kHz; SC-630/T: 250 Hz - 10 kHz; SC-650: 250 Hz - 6 kHz. Horizontal and vertical dispersion at -6 dB below the on-axis reference at 2 kHz shall be SC-610/T: 70° H x 100° V; SC-615/T: 70° H x 90° V; SC-630/T: 55° H x 70° V; SC-650: 55° H x 45° V. When used as a microphone, sensitivity referenced to 1 kHz, where 0 dB = 1 mW/10 dynes / cm² shall be SC-610/T: -24 dB; SC-615/T: -22 dB; SC-630/T: -20 dB.

The paging horn shall comply with the IEC IP-65 standard for dust and moisture-resistance and operate within a temperature range from -4° F to 131° F (-20° C to +55° C). The material / finish shall be horn flare: aluminum, off-white, powder coating, reflector horn and rear cover: ABS resin, off-white. All mounting hardware, including screws and bolts, shall be stainless steel. The paging horn shall include an integral speaker cable, insulated polyvinyl chloride type, with strain-relief, 0.24" (6 mm) diameter and 24" (600 mm) length.

Dimensions shall be SC-610/T: 6.77" W x 6.34" H x 7.40" D (172 mm x 161 mm x 188 mm); SC-615/T: 8.74" W x 7.04" H x 9.21" D (222 mm x 179 mm x 234 mm); SC-630/T: 11.22" W x 8.94" H x 10.91" D (285 mm x 227 mm x 277 mm); SC-650: 15.39" W x 11.93" H x 12.87" D (391 mm x 303 mm x 327 mm). Weight shall be SC-610: 1.76 lbs. (0.8 kg.); SC-610T: 2.43 lbs. (1.1 kg.); SC-615: 2.21 lbs. (1.0 kg.); SC-615T: 2.43 lbs. (1.1 kg.); SC-630: 3.09 lbs. (1.4 kg.); SC-630T: 4.19 lbs. (1.9 kg.); SC-650: 7.06 lbs. (3.2 kg.).

The paging horn shall be the TOA SC-610, SC-610T, SC-615, SC-615T, SC-630, SC-630T, SC-650.

TOA Electronics, Inc.

601 Gateway Boulevard
Suite 300
South San Francisco, CA 94080

Tel: 800-733-7088 Fax: 800-733-9766

www.toaelectronics.com

TOA Canada Corp.

Tel: 905-564-3570 Fax: 905-564-3569

Literature Order #: L-SC
Specifications subject to change without notice.
© 2005 TOA Electronics, Inc.